

A Low-Cost Class-E Power Amplifier with Sine-Wave Drive

John F. Davis¹ and David B. Rutledge¹

¹Department of Electrical Engineering, California Institute of Technology, Pasadena CA 91125

Abstract We present a 400-W Class-E amplifier for industrial applications. The transistor is the International Rectifier IRFP450LC Power MOSFET. The amplifier operates at 13.56 MHz and uses a drive level of 12 W to attain a drain efficiency of 86% and an overall efficiency of 84%. All harmonics are more than 40 dB below the carrier.

I. INTRODUCTION

The Class-E amplifier is a switching-mode amplifier [1,2]. The transistor operates as a switch, either completely *on* or completely *off*. Figure 1 shows an idealized Class-E circuit. When the transistor is off, current flows into a resonant load network, and there is a transient voltage that rises and falls. This voltage will return to zero smoothly, provided the load network is designed properly. When the transistor turns on, current rises smoothly until it switches off again. Losses are kept low by having the transistor switch on when both voltage and current are small. The resonant load network limits the Class-E amplifier to single-band operation.

The high efficiency of a Class-E amplifier makes it possible to produce high output power. The equation

$$P_o/P_d = \eta/(1 - \eta)$$

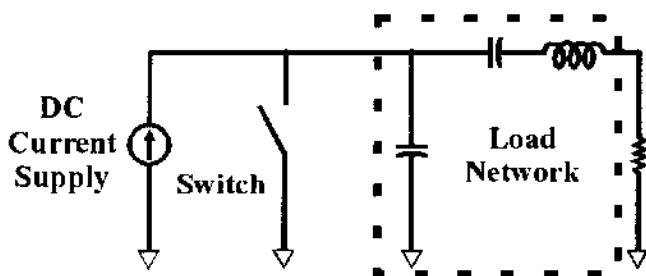

Fig. 1. An idealized Class-E amplifier. The switch represents the transistor that opens and closes at the RF frequency.

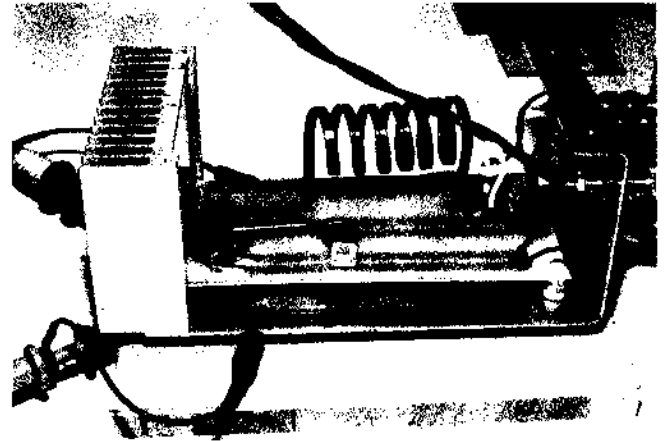

Fig. 2. Photograph of the 400-watt amplifier with cover removed. The transistor is mounted on a heatsink with dimensions 4.1'' x 3.0'' x 1.4''.

is a relationship between the output power P_o , the dissipated power P_d and the efficiency η . A Class-E amplifier operating at an efficiency of 84% can produce twelve times as much power as a 30% efficient Class-A amplifier, provided that dissipation is the limiting factor.

A 500-W Class-E push-pull amplifier was demonstrated by Davis *et al.* that yielded an efficiency of 92% at 1.7 MHz [3]. Sokal *et al.* later demonstrated a 27-MHz Class-E power amplifier that delivered 24 W at 92% efficiency using a single IRF520 MOSFET [4]. Recently, a 200-W, 13.56-MHz water-cooled amplifier was developed at Caltech that attained an efficiency of 91% [5]. Here, we report the development of a 400-W, single-ended, Class-E power amplifier for 13.56-MHz industrial, scientific and medical (ISM) applications. This amplifier uses International Rectifier's new low-charge power MOSFET, the IRFP450LC. This low-charge feature improves the switching speed of the device. The device comes in the TO-247 plastic package and costs \$8 in quantities of 100. A photograph of the amplifier is shown in Figure 2.

III. EXPERIMENTAL RESULTS

Figure 4 shows the efficiency of the amplifier versus drive power. In the measurement, the RF power is determined with a Bird 4421 Power Meter. The accuracy of the meter is specified by the manufacturer as $\pm 3\%$, but we have improved this to $\pm 0.5\%$ by a calibration procedure that uses temperature measurements on a 2-kW load [5]. The drain efficiency is 86% for input powers above 10 W. However, large drive levels increase the heat dissipated in the amplifier. To account for this, we have plotted the *overall efficiency*, or ratio of the RF output power to the total input power (DC plus RF). This is a better indicator as to how hot the transistor is going to get. We recommend a drive level between 10 and 18 W, which gives an overall efficiency of 84%.

The gate and drain waveforms are shown in Figure 5. We use a sine wave drive to resonate the reactance at the gate of the MOSFET. Note that the gate curve is quite bumpy, with ringing in the VHF range. This ringing is driven by the sudden turn-on and turn-off of the transistor, which acts rather like the gong of a bell. The experimental spectrum depicting these Turn-off and Turn-on ringing frequencies is shown in Figure 6. The spectrum also displays spurious responses in the high-VHF and UHF ranges due to the capacitance

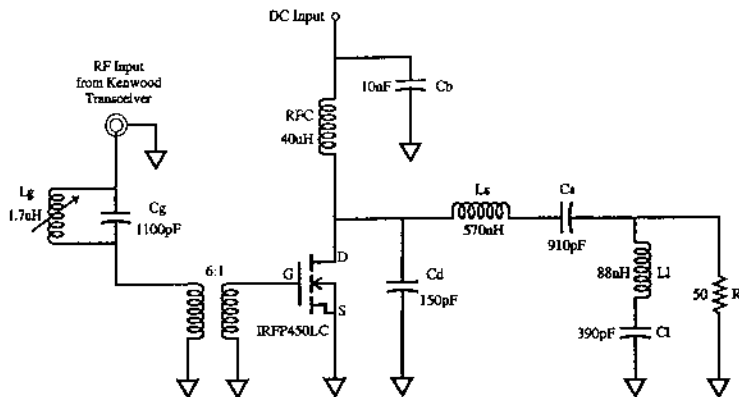

Fig. 3. 13.56-MHz Class-E circuit. The IRFP450LC Power MOSFET acts as a switch that opens and closes at the RF frequency. We use mica capacitors with a 1000-V rating. The 50- Ω resistor is the load.

II. THE 400-W AMPLIFIER

The amplifier circuit is shown in Figure 3. The 40- μ H choke (RFC) converts the 0 to 120-Vdc input from the power supply to a current source and the bypass capacitor (C_b) helps keep RF energy out of the power supply. The series inductor (L_s) and capacitor (C_s) form the resonant network that produces the rising and falling voltage waveform needed for the Class-E amplifier. Output power is determined by the supply voltage and the value of the series inductance (L_s). A supply voltage of 120 V gives an output power of 400 W. The tank circuit at the load (L_l and C_l) is a trap for the second harmonic. Without the trap, the second harmonic is at the -26-dB level. With the trap, all harmonics are more than 40 dB below the carrier. In addition, (L_l and C_l) transform the 50- Ω load to around 13 Ω , the appropriate range for a Class-E amplifier.

The impedance of the gate is small and primarily inductive with a reactance of about 4 Ω . There is also a resistive component of about 3 Ω from the parasitic series resistance in the gate and the drain "on" resistance is capacitively coupled to the gate. The transformer (T) is used to step up the 3 Ω of the gate to the 50- Ω impedance of the drive circuit. This gate transformer also sets the DC bias to zero volts and insures the transistor is *off* when it is not driven, as this is far below the threshold voltage of 4 V. Finally, capacitor (C_g) in parallel with the variable inductor (L_g) is used in tuning out the inductive reactance of the gate. The input SWR is typically 1.6:1.

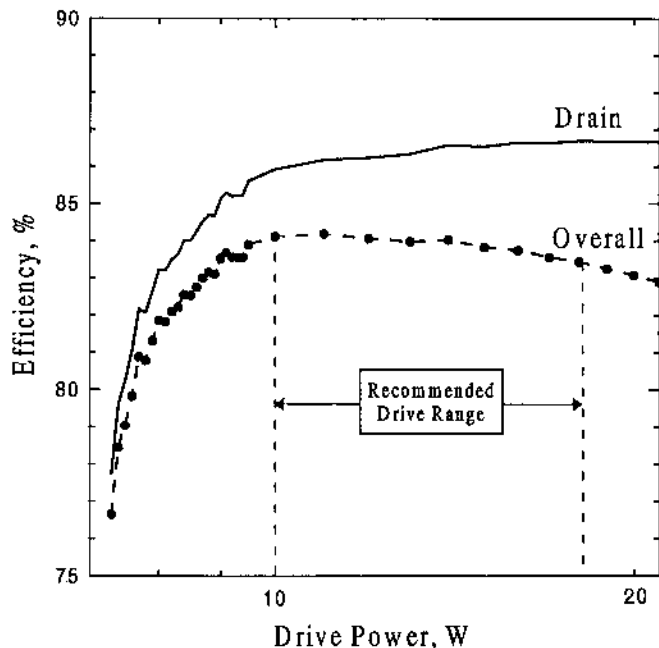

Fig. 4. Drain and overall efficiency versus drive power. We recommend keeping the drive power below 18 W to minimize heat dissipation in the MOSFET.

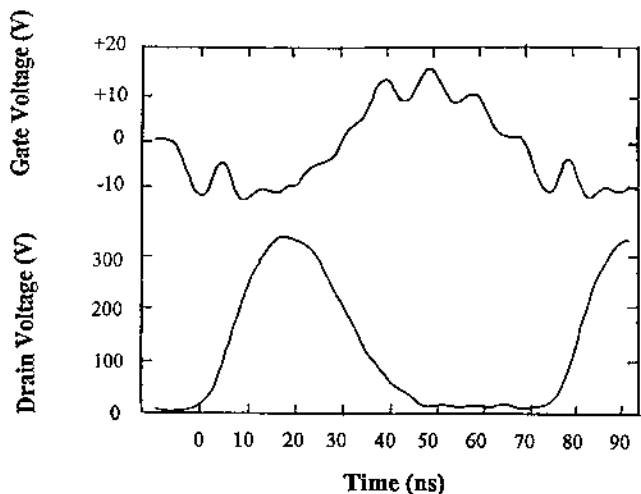

Fig. 5. Oscilloscope trace of the measured gate and drain voltage for the 400-W amplifier with 12-W drive. The DC supply is 120 V and the input SWR is 1.6:1. The peak gate voltage is 14 V, and the peak drain voltage is 350 V, safely within the manufacturer's ratings of 30 V and 500 V.

of the heatsink, insulator pad and MOSFET combination.

IV. COMPUTER SIMULATION

The schematic in Figure 7 represents the Class-E circuit implemented in SPICE. The Hewlett Packard HP4194A Impedance Analyzer was used to measure all of the components used in the model. The MOSFET is modeled as a switch with a linear capacitor (C_t) and a nonlinear dependent voltage source (E_{ct}) to model the square-root behavior of the drain-source capacitance. Figure 8 shows a comparison between the actual data and the simulation. The drain voltage waveform resulting from the simulation is shown in Figure 9 with the measured drain voltage drawn on top for comparison.

The RF harmonic spectrum was also calculated in SPICE and compared to the experimental data, shown in Figure 6. To simulate the spectrum it is important to include the parasitic inductance (L_{cd}) of the drain capacitor (C_d) and the parasitic capacitance (C_r) due to the heatsink, insulating pad and MOSFET assembly. The sum of the inductances (L_T) and (L_r) along with (C_r) predicts the resonant frequency at the 22nd harmonic or 298 MHz. Without these additions to the model, the theory predicts much lower harmonics than is observed experimentally.

The final SPICE simulation involved the calculation of component losses. This uses the measured values of

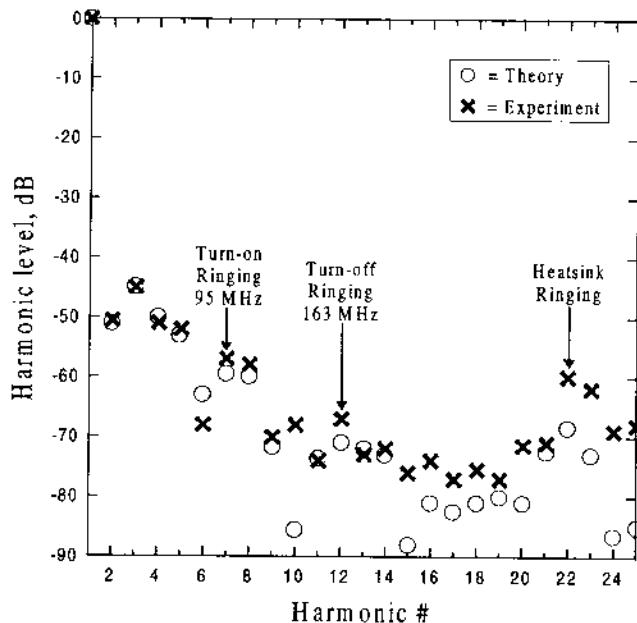

Fig. 6. RF output harmonic spectrum, theory and experiment. VHF ringing occurs at 95, 163 and 298 MHz.

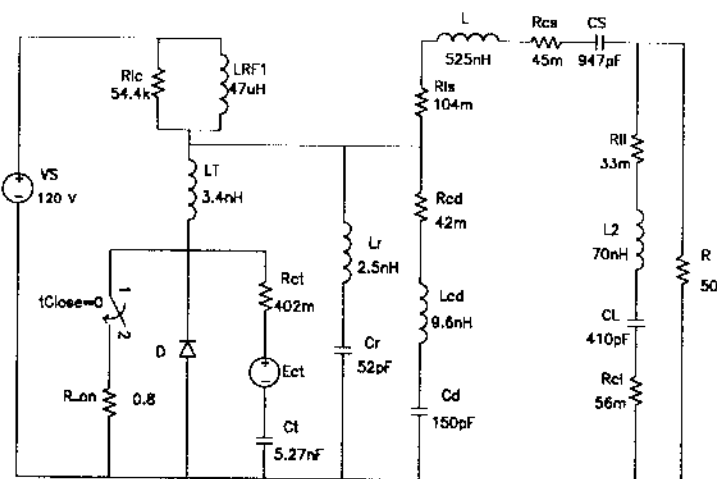

Fig. 7. 13.56-MHz Class-E SPICE model. All component values in the model are measured.

the resistances for the inductances and capacitors. The table in Figure 10 shows the results.

V. CONCLUSION

We have presented a 400-W Class-E amplifier that

	<u>Experiment</u>	<u>SPICE Model</u>
RF Output Power	400W	405W
DC Input Power	468W	463W
Drain Efficiency	86%	87%
Peak Drain Voltage	350V	362V

Fig. 8. Amplifier performance is compared with the simulation.

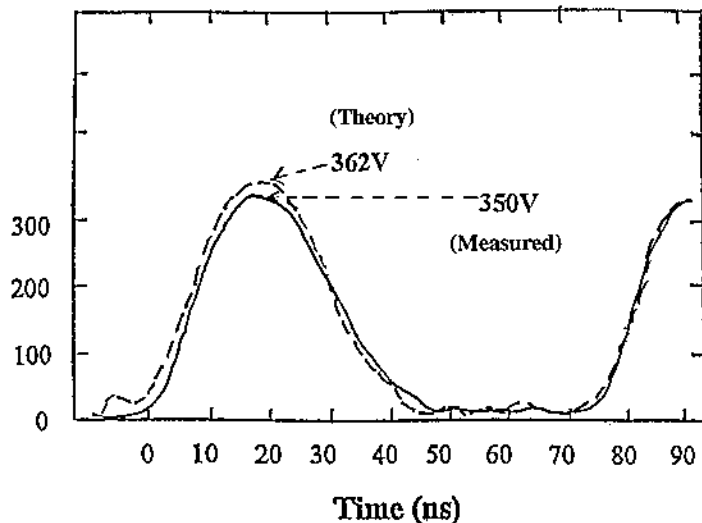

Fig. 9. Simulated and experimental drain voltage.

operates at 13.56 MHz and uses the low-charge International Rectifier IRFP450LC Power MOSFET. Sine-wave drive aids in resonating the gate reactance of the MOSFET and with the transformer, sets the DC bias to zero volts. A drive power of 12 W was used to attain a drain and overall efficiency of 86% and 84%, respectively. It should be possible to extend this work to higher frequencies. Recently, we demonstrated a 300-W amplifier at 21 MHz using the same transistor.

Component Losses

Inductors: L_s	= 0.3W
L_s	= 5.3W
L_l	= <u>1.4W</u>
Total Inductor Loss	7.0W

Capacitors: C_o	= 0.2W
C_s	= 2.3W
C_l	= <u>2.4W</u>
Total Capacitor Loss	4.9W

Transistor Losses

Off-Resistance	= 2.0W
On-Resistance	=30.3W
Turn-off Loss	=12.4W
Drive Power	= <u>12.0W</u>
Total Transistor Loss	56.7W

Total Loss = 68.6W

Junction Temperature (1.3 °C/W) 99 °C

Fig. 10 Calculated component losses. Simulation uses measured values.

V. ACKNOWLEDGMENTS

The authors appreciate the help and support received from the ETO Corporation and the Army Research Office. J. F. Davis holds an AASERT Fellowship.

VI. REFERENCES

- [1] G. D. Ewing, "High-Efficiency Radio-Frequency Power Amplifiers," Ph.D. Thesis. Oregon State University, Corvallis, Oregon, 1964.
- [2] N. O. Sokal and A. D. Sokal, "Class-E A new class of high-efficiency tuned single-ended switching power amplifiers," *IEEE Journal of Solid-State Circuits*, Vol. SC 10, pp. 168-176, June 1975.
- [3] C. Davis and W. Via, "Designing a Practical 500 Watt Class-E RF Amplifier", *Proc. RF Technology Expo*, Anaheim, CA, pp. 17-26, March 27-29, 1990.
- [4] N. O. Sokal and K.-L. Chu, "Class-E Power Amplifier Delivers 24 W at 27 MHz, at 89-92% Efficiency, Using One Transistor Costing \$0.85", *Proc. RF Expo East*, Tampa, FL, pp. 118-127, October 1993.
- [5] J. F. Davis and D. B. Rutledge, "Industrial Class-E Power Amplifiers with Low-Cost Power MOSFETs and Sine-Wave Drive", *Proc. RF Design '97 Conference and Expo*, Santa Clara, CA, pp. 283-297, September 1997.